

HunterDouglas

Cord Replacement Guide

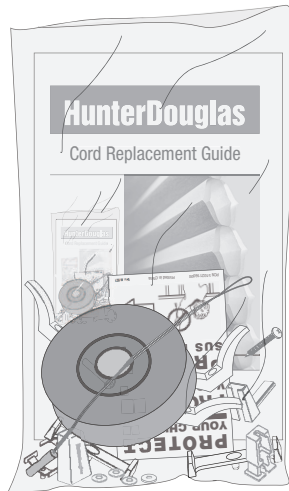

Duette® and Applause®
Honeycomb Shades
Cordlock Lifting Systems

CONTENTS

Getting Started:

Identify Components.....	3
Standard Cordlock Shade Variations	4
Tools and Fasteners Needed	5

Disassemble the Shade:

Remove the Shade from the Window	5
Pull the push tab to rotate the swivel arm to open position to release the headrail.....	5
Remove the Cordlock from the Headrail.....	5
Slide the Headrail Off the Fabric Stack.....	5
For Stop-Ball Shades – Disassemble the Stop-Ball.....	6
Remove the Old Cords.....	6

Replace the Cords:

Install the New Cord Guides	8
Measure and Cut the New Lift Cords	8
Thread the Lift Cords.....	9
Secure the Lift Cords.....	10

Reassemble the Shade:

For Shades with Washer Systems – Reinstall the Bottom Rail.....	11
Reinstall the Headrail.....	11
Thread the Cordlock.....	12
Reinstall the Cordlock.....	13
Reinstall the End Caps.....	13

Reinstall the Shade in the Window:

Reinstall the Shade in the Window	14
---	----

Install the Equalizer:

Install the Equalizer	15
-----------------------------	----

Adjustments:

Adjustments for Shades with the Pockets and Ferrules	18
For Equalizer Systems Only (See Page 4) – Tie on the Tassel	18

Operation:

Test the Shade Operation.....	19
-------------------------------	----

Child Safety:

Warning	Back Cover
---------------	------------

Questions?

Call the Hunter Douglas Customer Information Center at
1-888-501-8364.

© 2010 Hunter Douglas.

® Registered trademark of Hunter Douglas. ™ Trademark of Hunter Douglas.







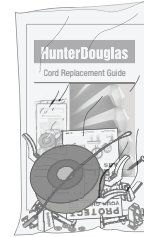

GETTING STARTED

Thank you for being a Hunter Douglas customer. With these new replacement components, your shade should provide you with many more years of continued satisfaction and enjoyment. Please thoroughly review these instructions before beginning.

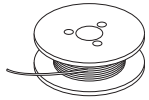

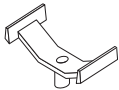
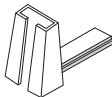
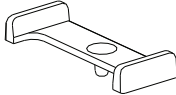
Identify Components

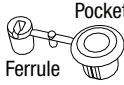
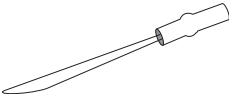
Cord Replacement Kit Components

	(1) Spool Of 96' Length Ultrawear® Cord*		(4) Washers
	(4) 3/8" Cord Guides		(1) Equalizer With Wedge
	(4) 3/4" Cord Guides		(1) Equalizer Housing
	(1) Tassel/Universal Cover		(4) Pockets and Ferrules
	(1) Threading Tool		(2) Cord Cleats With Installation Guide

*The latest version of the Ultrawear® cord has an estimated cord life at three times that of the previous 0.9mm cord. Take care not to twist the cord while handling.

Block and Tackle Cording

- Block and tackle cording was used on some larger honeycomb shades.

IMPORTANT: If you have a shade that uses block and tackle cording, you will need to use two or three cord replacement kits to rethread the shade.

Block and Tackle Cord Routing

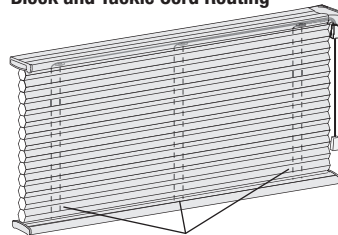

Double routs added support for larger shades.

GETTING STARTED

Standard Cordlock Shade Variations

Hunter Douglas cordlock shades have evolved over time. Use the following illustration to determine what type of cordlock and lifting system is on your shade.

- 1 **Equalizer System.** The lift cords are crimped together using a wedge.
- 2 **Stop-Ball "A" System.** A component known as a stop-ball houses the equalizer and allows for a single cord with tassel.
- 3 **Stop-Ball "B" System.** Universal covers are used for both the equalizer and the tassel.

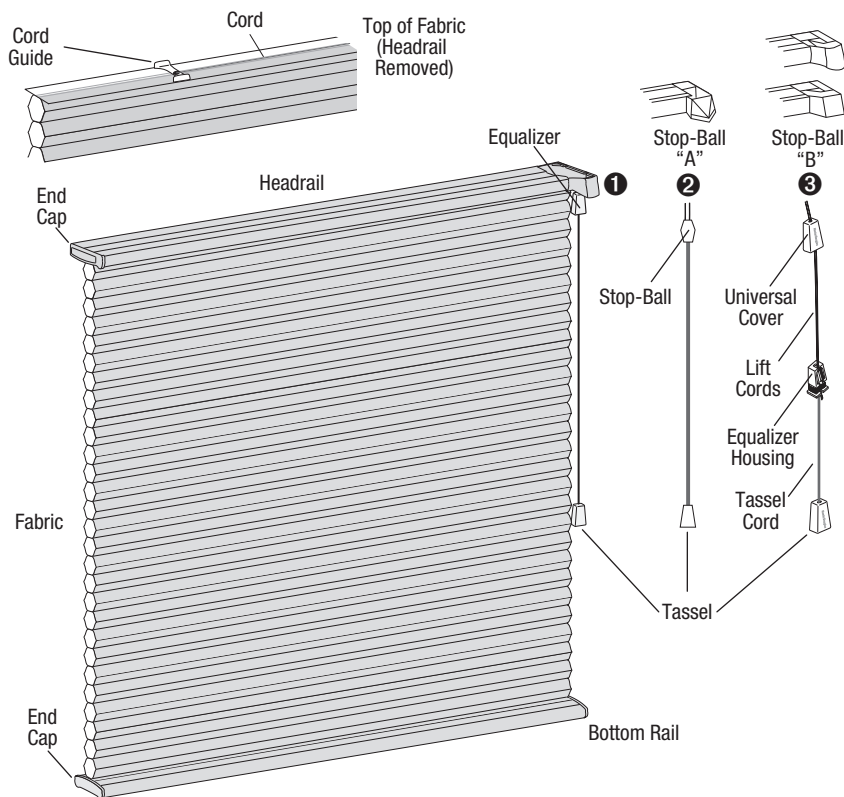

Possible Bottom Rail Configurations

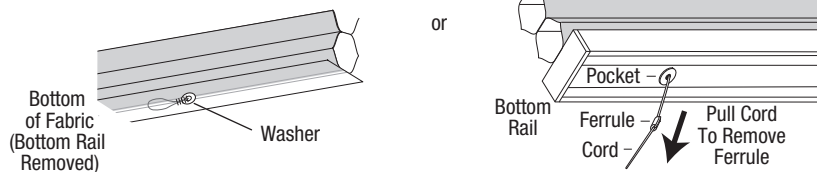

DISASSEMBLE THE SHADE

Tools and Fasteners Needed

- Flat blade screwdriver
- Mallet
- Measuring tape
- Needle-nose pliers
- Scissors

Remove the Shade from the Window

Standard Brackets

- Fully raise the shade.
- Loosen the tab screw on each bracket to release the headrail.

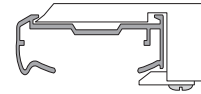

Swivel Brackets

- Fully raise the shade.

Pull the push tab to rotate the swivel arm to open position to release the headrail.

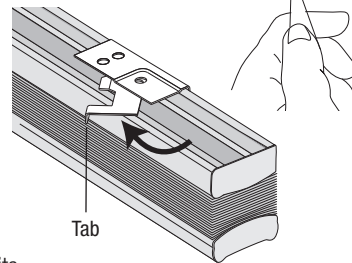

Remove the Cordlock from the Headrail

- Use a flat blade screwdriver to pry the cordlock and its cover from the headrail. Keep the cordlock and cover for reuse.
- Examine how the cords are threaded through the cordlock.
- Cut the cords near the end of the rail and pull the cut ends out through the cordlock.

CORDLOCK "A"

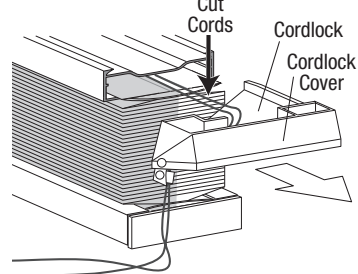

CORDLOCK "B"

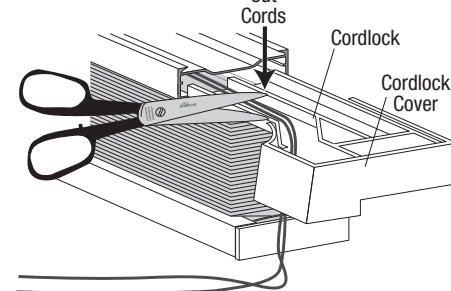

Slide the Headrail Off the Fabric Stack

- While holding the fabric stack in place, slide the headrail off of the fabric stack.

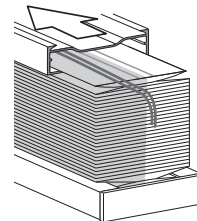

DISASSEMBLE THE SHADE

For Stop-Ball Shades – Disassemble the Stop-Ball

Stop-Ball “A” Shades

- Insert a screwdriver into the slot at the bottom of the stop-ball and carefully pry off the cover.
- Pull out and discard both the equalizer and lift cords.

IMPORTANT: Do not discard the tassel (not shown), tassel cord, stop-ball body, or stop-ball cover. Set these items aside for later use when reinstalling the shade.

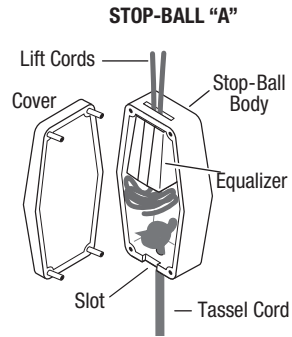

Stop-Ball “B” Shades

- Pull down on the tassel cord while holding the universal cover to access the equalizer housing containing the equalizer.
- Pull out and discard both the equalizer, equalizer housing, and lift cords.

IMPORTANT: Do not discard the tassel (not shown) or tassel cord. Set these items aside for later use when reinstalling the shade.

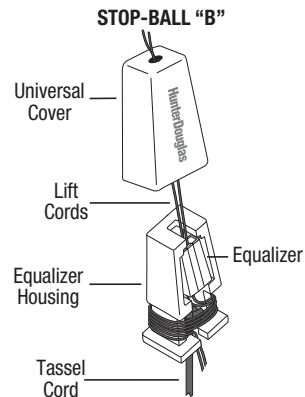

Remove the Old Cords

Determine Your Fabric Stack's Cord System

If there is no pocket and ferrule under the bottom rail, then you have a washer system. Proceed to the appropriate section on the next page for your shade's cord system.

Pocket and Ferrule System

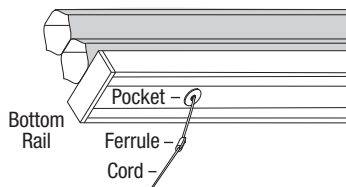

Washer System

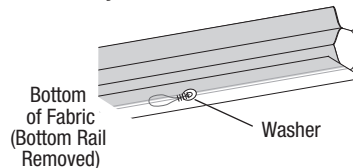

DISASSEMBLE THE SHADE

Remove the Old Cords from the Pocket and Ferrule System

- To access the cord, either pull the cord downward from the pocket to release the ferrule, or use a flat-blade screwdriver to pry up the pocket and remove it from the bottom rail.
- Replace the pocket with a new one from the replacement kit if it is cracked, scratched, or worn.

IMPORTANT: You may need to use a tweezer or needlenose pliers to get hold of the cord inside of the pocket. The cord may have been previously cut flush with the pocket.

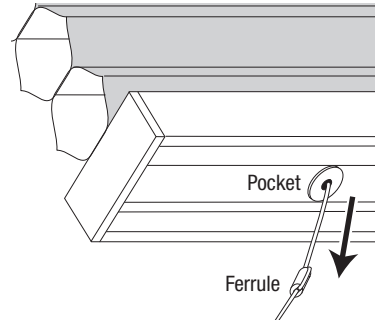

- Cut the cord and discard all the components.

Remove the Old Cords from a Washer System

- Remove the end cap from the bottom rail.

- Use a flat blade screwdriver to pry one end cap from the bottom rail. Keep the end cap for reuse later.

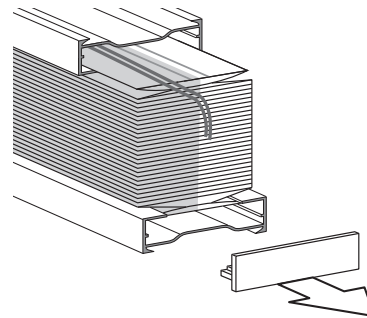

- Remove the bottom rail from the fabric.

- While holding the fabric stack in place, slide the bottom rail off of the fabric stack.

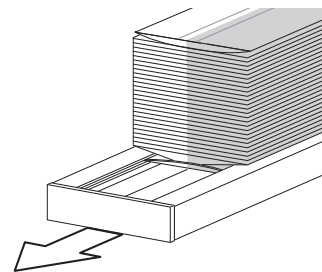

- Discard the washers, cords, and cord guides.

- Pull the washers and cords from the bottom of the fabric stack or rail and discard them.
- Remove the cord guides from the top of the fabric stack and discard them.

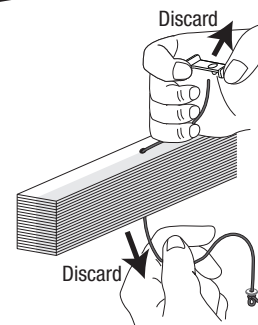

REPLACE THE CORDS

Install the New Cord Guides

- Select new cord guides from the replacement kit. Pick the cord guides that best fit the fabric width, from the two sizes provided.
- Be sure the thin metal filler strip located in the top cell of the fabric stack, is flush with the end of the fabric stack and the rout holes in the filler strip line up with the holes in the fabric stack.
- **For Stop-Ball “A” and “B” Shades:** Press the tab on the cord guide all the way through the hole in the TOP cell and filler strip of the top headrail cell ONLY.
- **For Block and Tackle Shades:** Press the tabs on the cord guides all the way through the holes in the TOP cell and filler strip of BOTH the top headrail cell and bottom cell.
- Extend the headrail cells as shown to ensure the bottom cell and fabric cells drop free of the cord guide.

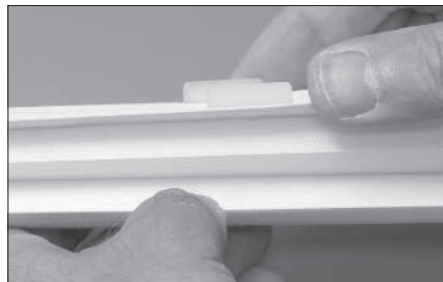
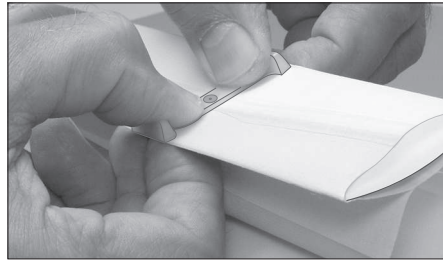
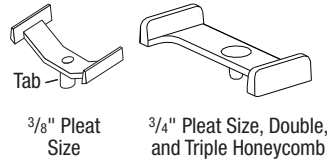

Measure and Cut the New Lift Cord

- Using the following formula, cut a new cord for each hole in the fabric stack.

IMPORTANT: Always pull the cord off the spool by rotating the spool, as opposed to twisting the cord off a stationary spool. Proper unwinding of the cord eliminates cord twists.

IMPORTANT: Two or three cord replacement kits are needed for block and tackle shades. If your shade has block and tackle cording with cord guides on the top and bottom of the shade, install new cord guides in the bottom of the shade too. See *Block And Tackle Cording* on page 3.

- **For Stop-Ball “A” and “B” Shades**
Cord Length = Shade Height + Shade Width + 24".

- **For Block and Tackle Shades** (see *Block and Tackle Cording* on page 3)
Cut one cord for every two holes.
Cord Length = 2 x Shade Height + Shade Width + 24".

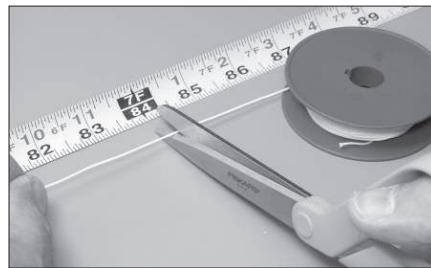

REPLACE THE CORDS

Thread the Lift Cord

For Shades with Pocket and Ferrule Systems

- Push the threading tool up through the pocket in the bottom rail then through the fabric stack, and then through the cord guide.

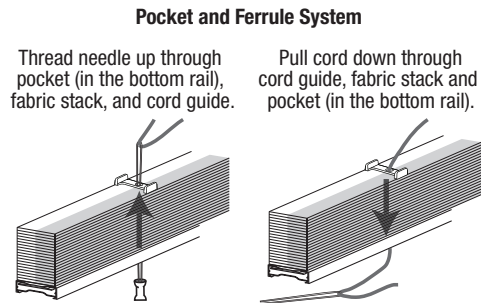

For Shades with Washer Systems

- Push the threading tool up through the hole in the bottom of the fabric stack, then through the fabric stack, and then through the cord guide.
- Insert the end of the new cord through the loop of the threading tool.
- Pull the threading tool down through the fabric stack.
- Follow the same procedure for each hole.

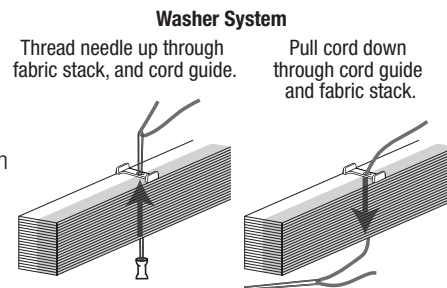

For Shades with Block and Tackle Only

- Cord lengths are threaded through the fabric twice.
- Place cord guides through all top and bottom holes and their filler strips. This illustration demonstrates block and tackle cording for a shade with three lift cords.

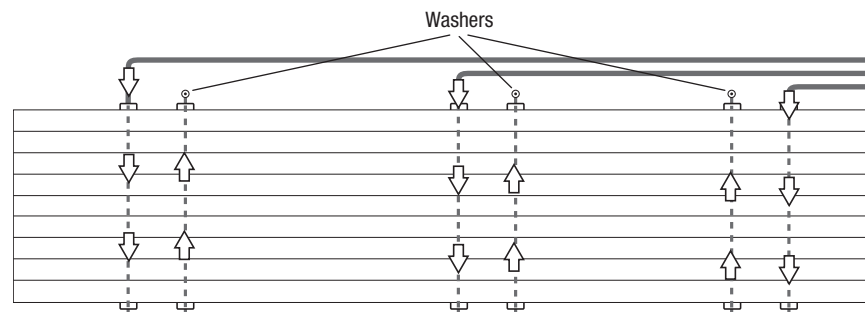

- Push the threading tool down through the cord guides from the top of the fabric stack, and through the cord guide at the bottom of the fabric stack.
- Thread the new cord through the loop of the threading tool.
- Pull the cord up through the hole.
- Follow this same procedure for each hole.

REPLACE THE CORDS

Secure the Lift Cords

For Shades with Washer Systems

- Thread the end of the cord coming out of the bottom of the fabric stack (or at the top of the fabric stack for block and tackle shades) through the washer included in the replacement kit.
- Pull the cord taut to ensure that the washer fits snugly against the shade. Do this for each cord.
- Tie a triple knot below the washer, as shown. The washer prevents the cord from slipping back through the fabric stack.

IMPORTANT: The knot will be hidden when the rail is reinstalled.

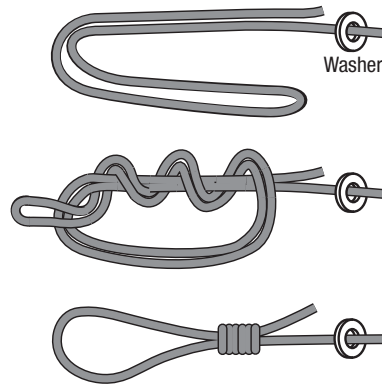

For Shades with Pockets and Ferrules Systems

- If replacing a pocket, thread the cord through the pocket.
- Insert the pocket into the hole and press it down snug against the bottom rail.
- Remove the ferrule attached to the pocket and thread it onto the end of each lift cord, tapered end toward the pocket.
- Loop the cord around the ferrule and thread it through the ferrule again.
- With a few inches of cord projecting from the ferrule, tighten the loop on the ferrule.
- Be sure the cord loop drops into the notch on the ferrule as you tighten the cord.
- Press each ferrule into its pocket.

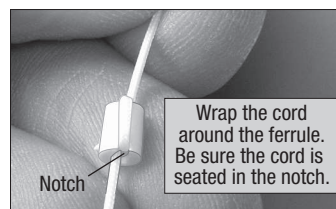
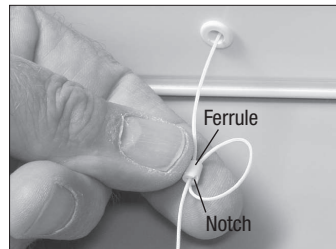
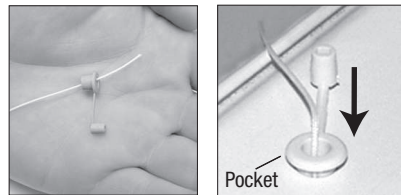

REASSEMBLE THE SHADE

For Shades with Washer Systems – Reinstall the Bottom Rail

- Slide the bottom fabric cell (with the filler strip inside the cell) into the fabric channel of the bottom rail as shown.
- The edge of the filler strip should “catch” under the lip of the bottom rail.

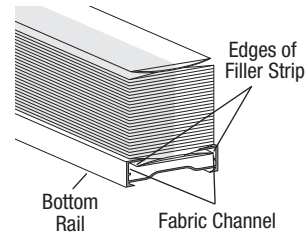

Reinstall the Headrail

- Lay the lift cords along the center of the top cell toward the cordlock side of the fabric stack.
- Keep the cord guides aligned and **do not cross the cords**. Make sure the cords are straight and not tangled or twisted.
- While holding the cords taut, slide the headrail over the top fabric cell. As you come to each cord guide, align the cord guide to the fabric stack, before you slide the rail over it.

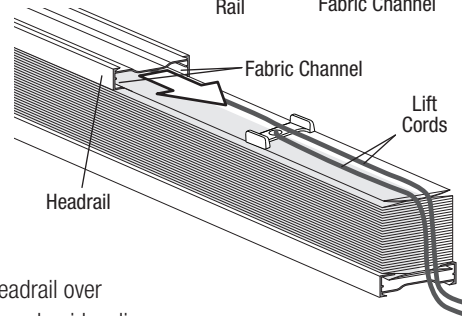

IMPORTANT: Make sure that the fabric does not catch on the corners of the headrail channels. $\frac{3}{8}$ " Architella® fabric has a tendency to catch on the channels and tear. To avoid this, gather the fabric on top of the filler strip and away from its edges before sliding the headrail over the top fabric cell.

IMPORTANT: With the newer Duette® headrails, make sure the tab on the cord guide goes into the channel in the REAR of the headrail, as shown.

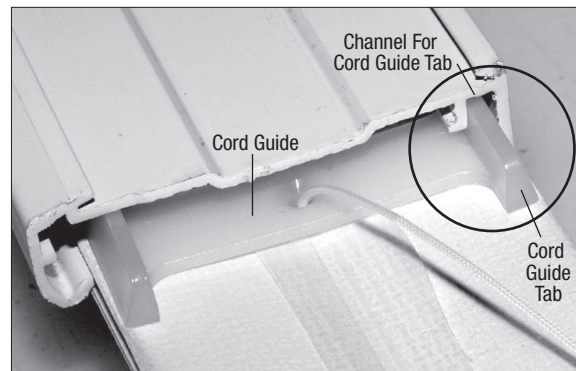

REASSEMBLE THE SHADE

Thread the Cordlock

- Insert the threading tool up through the bails and out the top of the cordlock.
- Loop all the cords through the threading tool.
- Pull the threading tool with cords down through the cordlock and bails.
- Run the lift cords under the tab in the cordlock, keeping the cords straight.

IMPORTANT: Cordlock "A" does *not* have a tab.

CAUTION: Do *not* cross the cords.

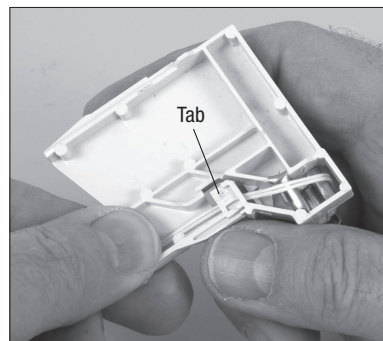
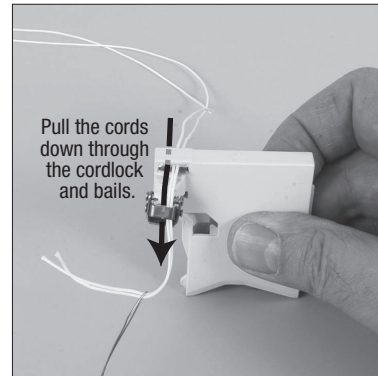
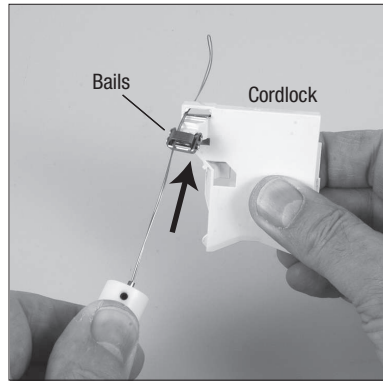

- Attach the cordlock cover.
 - Position the front surface of the cordlock body inside the cover.
 - Snap the rear of the cover in place.
 - Then snap the front of the cover in place.

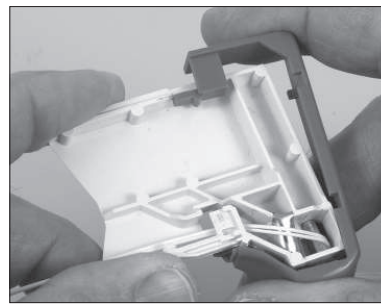

REASSEMBLE THE SHADE

Reinstall the Cordlock

- Pull the cords straight down from the cordlock to fully raise and tightly stack the fabric of the shade.
- While holding the cords taut, align the cordlock to the grooves in the headrail. Slide the cordlock all the way into the headrail.

IMPORTANT: Maintain a tension on the cords to avoid pinching, crossing, or twisting them.

IMPORTANT: Hold the cord ends to prevent them from traveling back through the fabric stack.

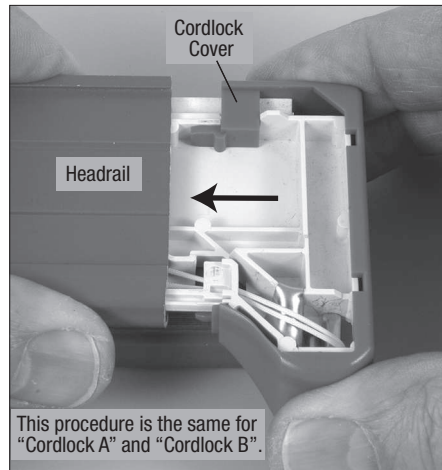

Reinstall the End Caps

- Reinstall all the end caps.
 - **Duette® Shades:** Align and install the endcaps as shown.
 - **Applause® Shades:** Align and install the endcaps as shown.

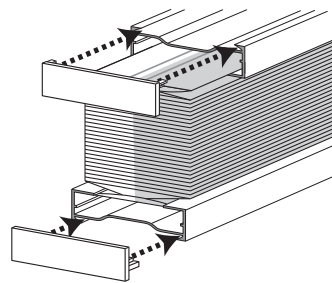

REINSTALL THE SHADE

Reinstall the Shade in the Window

IMPORTANT: Keep the shade fully raised and tightly stacked while installing the shade.

- Place the shade so the colored side of the fabric and the cordlock face you.
- Insert the headrail into the installation brackets at an angle and rotate it upward to snap it into place.
- Tighten the tab screw on each bracket until snug. Do not overtighten.

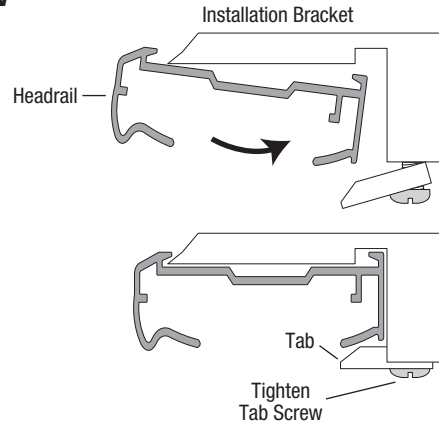

IMPORTANT: Make sure that the shade fabric is not trapped between the headrail and tabs on the installation brackets.

INSTALL THE EQUALIZER

Install the Equalizer

Lock the Cords in Place

- While holding the cords, pull the cords toward the center of the shade to release the cordlock. Do not let go of the cords.
- Slowly lower the shade to where you want the bottom rail to rest.
- Lock the cords in place by pulling them toward the outside of the shade.

Stop-Ball "A" or Stop-Ball "B" Systems – Thread the Stop-Ball Body/Universal Cover

- Use the threading tool to pull the cords through the slot in the top of the stop-ball body (stop-ball "A") or the hole in the top of the universal cover (stop-ball "B").

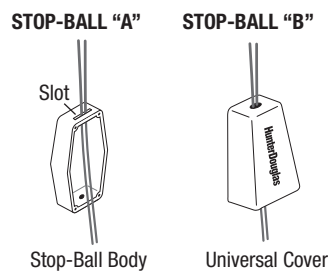

Install the Cords into the Equalizer

- Snap the wedge piece off from the equalizer piece.
- Position the stop-ball body or universal cover above the equalizer.

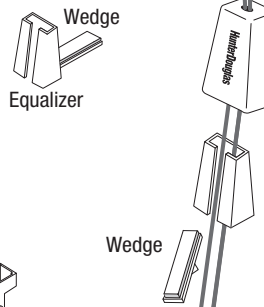

- Place the equalizer on the cords, 1" from the cordlock bails.
- Place the cords into the equalizer with the smaller end of the equalizer up.

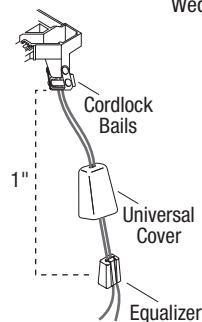

- Keeping the cords in the equalizer taut, slide the wedge halfway into the equalizer. Make sure the rib is against the cords locking them in place.

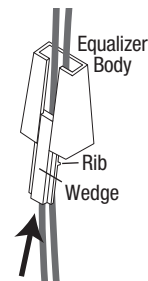

IMPORTANT: Do not completely lock the wedge into position. The equalizer should remain partially installed until the shade assembly is adjusted.

INSTALL THE EQUALIZER

Roughly Adjust the Equalizer

Adjust the cord going through the equalizer to level the bottom rail or change the shade height.

- Check that the cordlock is in the locked position.
- Loosen the equalizer by pulling down on the cords while holding the equalizer firmly to release the wedge.
 - **To Level the Bottom Rail:** Pull each cord individually.
 - **To Adjust the Shade Height:** Pull both cords together evenly with the cords taut.

IMPORTANT: For larger shades there are additional lift cords to support the added size. Be sure to pull evenly on ALL cords when adjusting shade height.

- Slide the wedge securely into the equalizer, making sure the rib is against the cords locking them in place.
- Double check that the bottom rail is at the desired position.
- Lock the wedge in place. Use pliers or push the wedge against any type of flat surface until it is flush with the bottom of the equalizer to lock it in place.

IMPORTANT: Do not cross the cords in the equalizer. The wedge cannot be adequately secured if the lift cords are crossed.

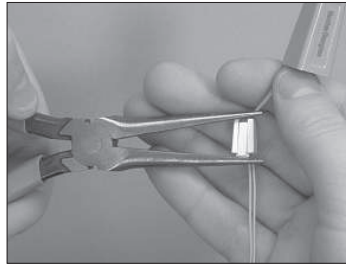

For Stop-Ball “A” Shades Only – Install the Equalizer into the Stop-Ball Body

- Place the equalizer inside the stop-ball body.
- Trim the lift cords 4" below the equalizer.
- Fit the ends of the lift cords into the stop-ball body by holding the equalizer with one hand and twisting the lift cords with your thumb and forefinger.
- After each twisting motion, hold the twisted cords inside the stop-ball body.

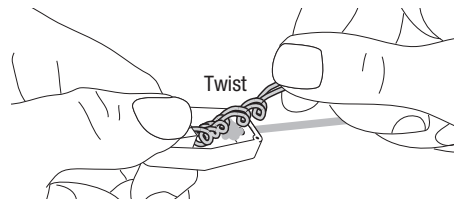
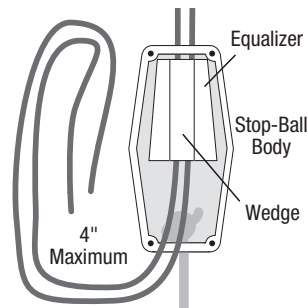

INSTALL THE EQUALIZER

- Twist the cords until they are all inside the stop-ball body.
- Install the stop-ball cover by fitting the four pegs on the cover into the holes on the stop-ball body.

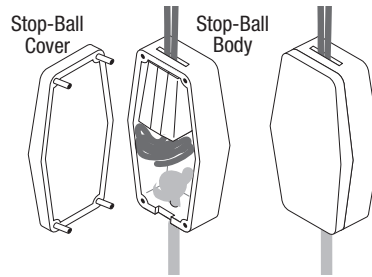

For Stop-Ball “B” Shades Only – Install the Equalizer into the Equalizer Housing

- Select the equalizer housing from the replacement kit.
- Retrieve the tassel cord that you set aside earlier. Place the knotted end of the tassel cord into the slot at the base of the equalizer housing.
- Place the equalizer into the equalizer housing.

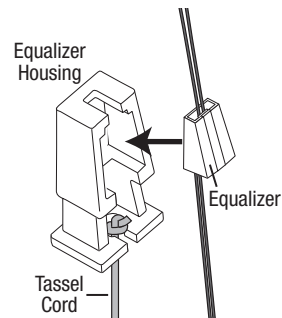

- Wrap the remaining lift cords a maximum of 4 times around the base of the housing, then down the slot at the bottom of the housing.
- Hold the lift cords and tassel cord taut and slide the universal cover over the equalizer housing assembly.
- Check the bottom rail to see that it is level. Make any final adjustments to the equalizer, if necessary.
- Trim excess lift cords flush with the bottom of the equalizer housing.

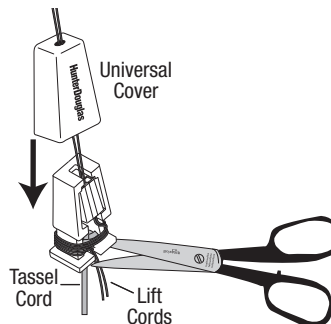

IMPORTANT: Be sure to cut only the lift cords. **Do not cut the tassel cord.**

ADJUSTMENTS

Adjustments for Shades with the Pockets and Ferrules

Shade height and adjustments to level the bottom rail can be made by adjusting the cord on the underside of the bottom rail.

- Locate the ferrule, seated in the pocket in the bottom rail.
- Remove the ferrule by pulling on the excess cord. If the cord has been trimmed, you will need to use needlenose pliers to access it.
 - If you need to rethread the ferrule, thread the end of the cord into the tapered end of the ferrule. Loop the end around the ferrule and back through the tapered end. Make sure the loop fits into the groove on the side of the ferrule.

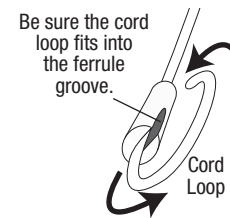
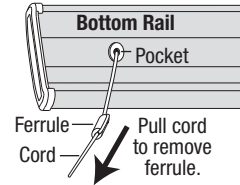

- **To shorten the cord:** Hold the cord tight under the ferrule. Then slide the ferrule up toward the pocket.
- **To lengthen the cord:** Hold the cord tight between the pocket and the ferrule, then slide the ferrule down, away from the pocket.

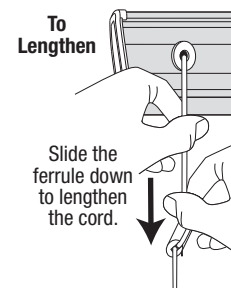
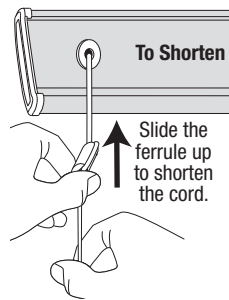

- After adjusting, place the ferrule fully back into the pocket.
- Once you are certain of the final adjustments, tape the extra cord length to the bottom rail, or place them into the groove on the bottom rail for future adjustments.

For Equalizer Systems Only (See Page 4) – Tie on the Tassel

- Lower the shade until it is fully extended.
- Thread the cords through the tassel.
 - IMPORTANT:** For larger shades there are additional lift cords to support the added size. Be sure to capture all the cords through the tassel.

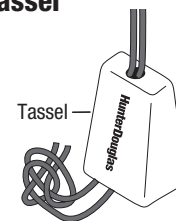

- Adjust the cords to assure the bottom rail is level.
- Tie a double knot in the cords two-thirds down the shade from the cordlock.
- Keep cords taut when tying them to avoid any slack.
- Trim off the excess cord.

OPERATION

Test the Shade Operation

- Keep the cord close to the fabric when operating the shade.
- To raise or lower the shade, disengage the cordlock by moving the cord toward the center of the shade.
- Lock the cordlock by returning the cord to the original position, or pulling the cords toward the outside of the shade.

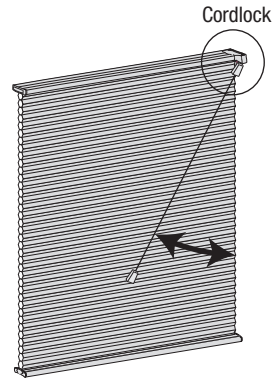

CHILD SAFETY

	<p>! WARNING</p> <p>For more safety information call 1-888-501-8364 in the U.S. or 1-866-662-0666 in Canada.</p>
---	---

Young children can wrap cords around their necks and STRANGLE.

- Always keep cords out of the reach of children.
- Move cribs, playpens and other furniture away from cords. Children can climb furniture to get to cords.
- Do not tie cords together. Make sure cords do not twist together and create a loop.

Hunter Douglas provides cord cleats and we recommend their use.

- Cord Cleats: Attach two cord cleats 6" to 12" apart at a height where they will be out of the reach of children. Take into account that a child may stand on furniture attempting to reach the cords. Be sure the cleats are firmly secured. Once the cleats are attached, wrap excess cord around them after each use of the shade.



HunterDouglas

hunterdouglas.com

