

# HunterDouglas

## Pull Cord Assembly Replacement Guide

---

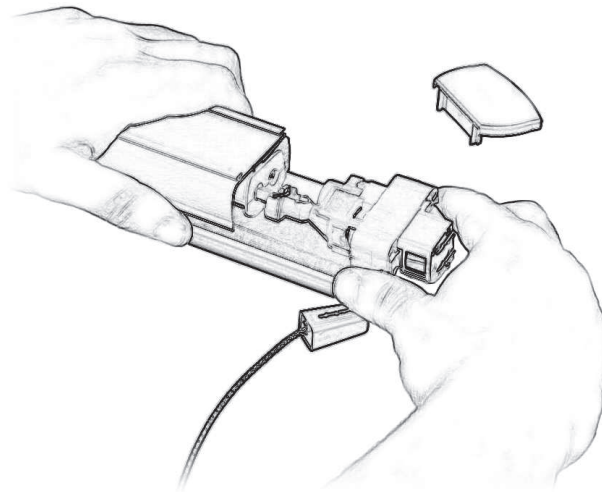

---

Duette<sup>®</sup> with UltraGlide<sup>®</sup>  
Honeycomb Shades

## CONTENTS

---

### Disassemble the Shade:

Parts (Depending upon Order).....	3
Additional Parts (Depending upon Order) .....	3
Tools and Fasteners Needed .....	3
Remove the Shade from the Window .....	3
Remove the End Cap from the Headrail .....	4
Slide the Headrail Open .....	4

### Remove the Pull Cord Assembly (PCA):

Lift the PCA from the Fabric Stack.....	5
Remove the Connector or Gear Assist (for Wider Shades) from the PCA.....	5

### Attach the New PCA:

Attach the Connector or Gear Assist (for Wider Shades) to the New PCA .....	7
---	---

### Replace the Connector or Gear Assist (If Necessary):

Remove the Shaft and its Attached Components from the Connector or Gear Assist .....	9
Insert a new Shaft Retaining Clip into the New Connector or Gear Assist.....	9
Insert the Shaft into the Connector or Gear Assist.....	10
Attach the Connector or Gear Assist to the PCA .....	10

### Reassemble the Shade:

Insert the Tab on the New PCA into the Fabric Hole .....	11
Slide the PCA into the Headrail.....	11
Reinstall the End Cap .....	12
Check for any Caught Fabric.....	12

### Transfer the Tassel Assembly:

Remove the Tassel from the Old PCA.....	13
Release the Equalizer Housing from the Tassel Cover .....	13
Release the Wedge from the Equalizer.....	14
Reassemble the Tassel to the New PCA.....	14

### Reinstall the Shade

Reinstall the Shade .....	15
Warning .....	16

---

### Questions?

Call the Hunter Douglas Customer Information Center at **1-888-501-8364**.

© 2011 Hunter Douglas.

® Registered trademark of Hunter Douglas. ™ Trademark of Hunter Douglas.



## DISASSEMBLE THE SHADE

### Parts (Depending upon Order)

Check to make sure that you received the correct Pull Cord Assembly (PCA) that will fit your particular shade. The PCA is right or left control specific.

The three types of PCA's are:

- 3/8" pleat size UltraGlide® PCA or,
- 3/4" pleat size UltraGlide PCA or,
- 1 1/4" pleat size UltraGlide PCA

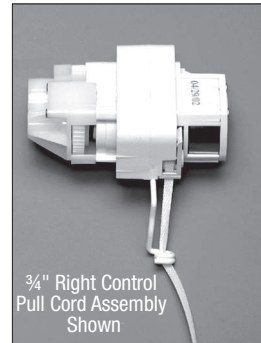

### Additional Parts (Depending upon Order)

- Connector  
Part # 2982021000



- Shaft Retainer Clip  
Part # 2982020000



- Gear Assist  
Part # 2983681000



### Tools and Fasteners Needed

- Small flat blade screwdriver
- Mallet
- Needlenose pliers

### Remove the Shade from the Window

- Lower the shade approximately 4".
- While holding the headrail, push back on the bottom tab of the installation bracket using a small flat blade screwdriver to release the bottom edge of the headrail.
- After releasing the bottom edge, roll the back of the headrail down and out from the bracket.

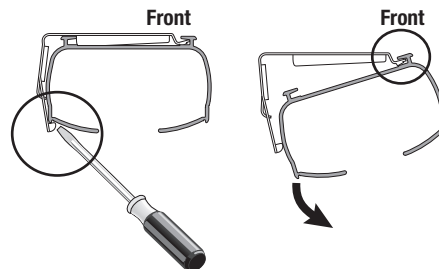

## DISASSEMBLE THE SHADE

---

### Remove the End Cap from the Headrail

- Tap the pull cord side end cap off with a flat blade screwdriver.

**CAUTION:** Be careful not to damage the end cap; you will need it for reassembly.



### Slide the Headrail Open

- Hold the cord against the bottom rail and slide out the PCA, fabric stack, and bottom rail far enough to expose the entire PCA.

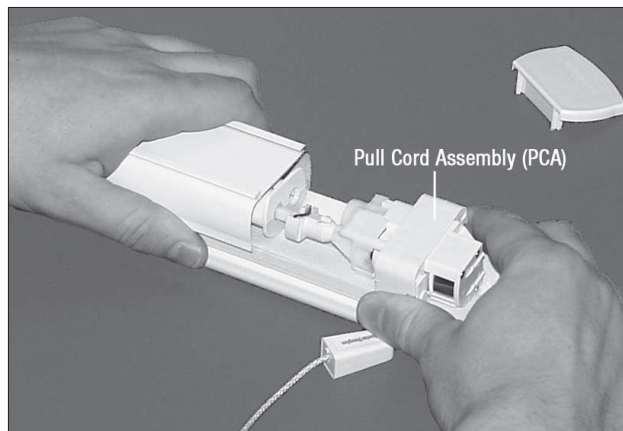

---

## REMOVE THE PULL CORD ASSEMBLY (PCA)

### Lift the PCA from the Fabric Stack

- Lift the tab on the PCA up from the fabric stack.

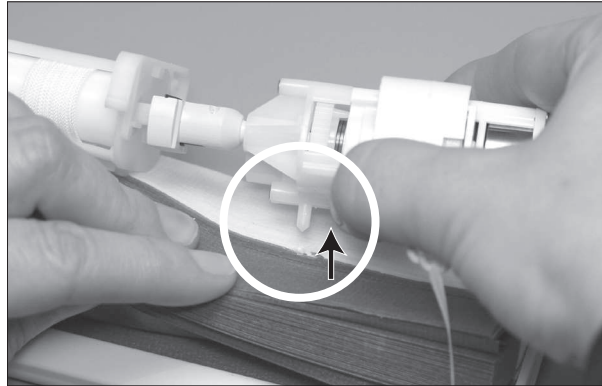

### Remove the Connector or Gear Assist (for Wider Shades) from the PCA

#### Removing the Connector from the PCA

- Insert the flat blade screwdriver between the connector and the PCA.
- Slightly twist the screwdriver to remove the PCA from the connector.

**NOTE: DO NOT** throw away the old PCA. Parts from the old PCA will be used later in these instructions.

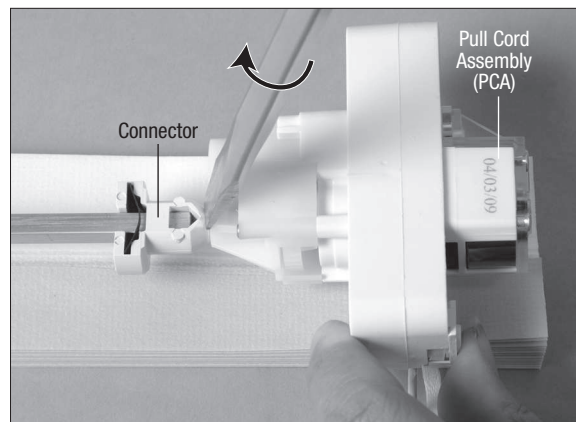

## **REMOVE THE PULL CORD ASSEMBLY (PCA)**

---

### **Removing the Gear Assist from the PCA**

- Insert a flat blade screwdriver between the gear assist and the PCA.
- Slightly twist the screwdriver to remove the PCA from the gear assist.
- If you need a new gear assist, contact the Customer Information Center at 1-888-501-8364.

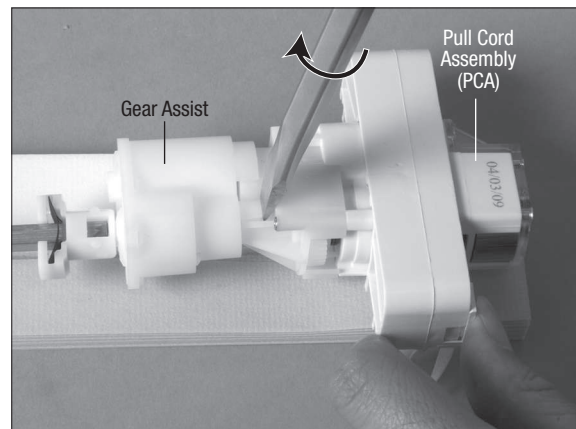

---

## ATTACH THE NEW PCA

### **Attach the Connector or Gear Assist (for Wider Shades) to the *New PCA***

Both the connector and the gear assist are designed to attach to the PCA.

#### **Attaching the Connector to the New PCA**

- Insert the connector with the shaft and other headrail components attached, into the hole in the new PCA, rotating it back and forth to seat it securely. The connector should snap into place, flush against the PCA.

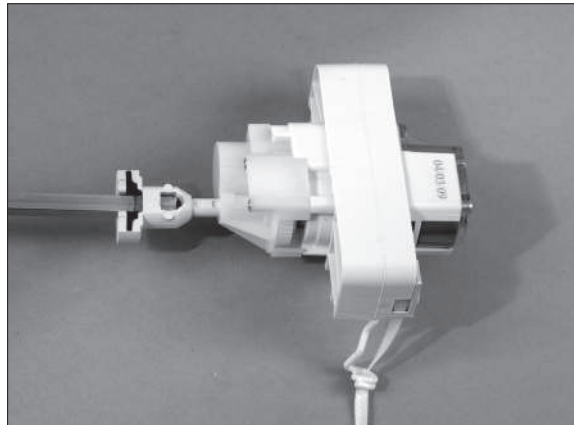
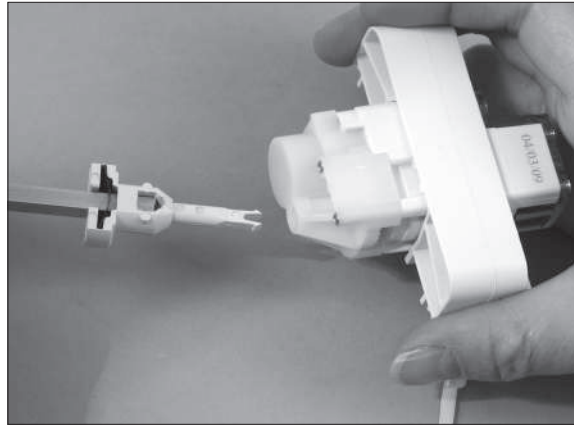

## **ATTACH THE NEW PCA**

---

### **Attaching the Gear Assist to the New PCA**

- Insert the gear assist with the shaft and other headrail components attached, into the hole in the new PCA, rotating it back and forth to seat it securely. The gear assist should snap into place, flush against the PCA.

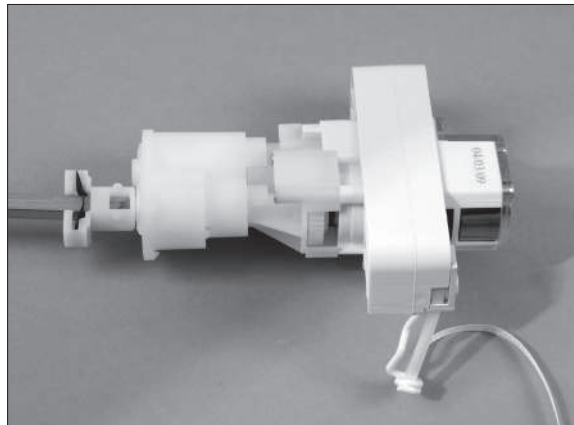
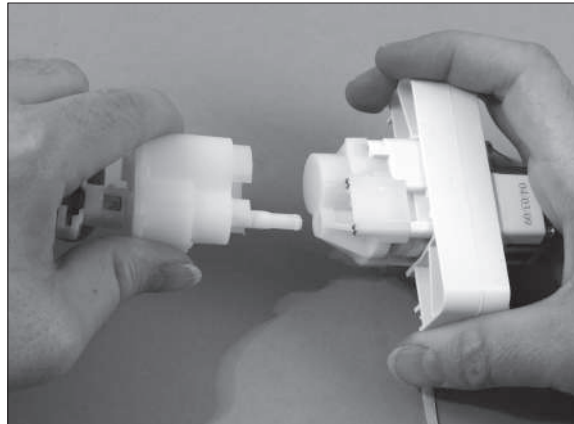



---

## REPLACE THE CONNECTOR OR GEAR ASSIST (IF NECESSARY)

If replacing the connector or gear assist, note that both require a new shaft retainer clip.

### Remove the Shaft and its Attached Components from the Connector or Gear Assist

- To release the shaft, use needlenose pliers and pull the shaft retainer clip toward the connector or gear assist.

**TIP:** It may help to use a small flatblade screwdriver to push the shaft out of the connector or gear assist, as you squeeze the needlenose pliers.

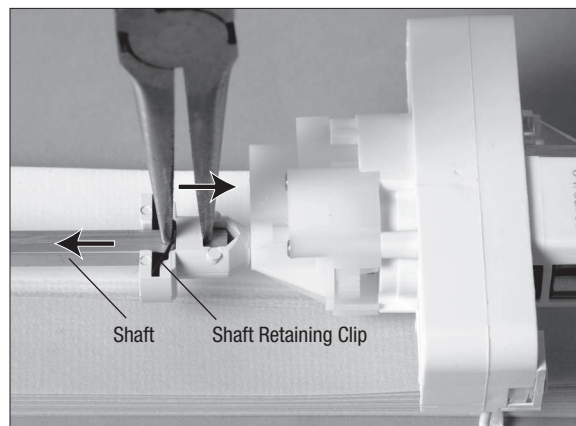

### Insert a new Shaft Retaining Clip into the New Connector or Gear Assist

- Insert the shaft retaining clip into the slot in the connector or gear assist, with the flanges toward the PCA.

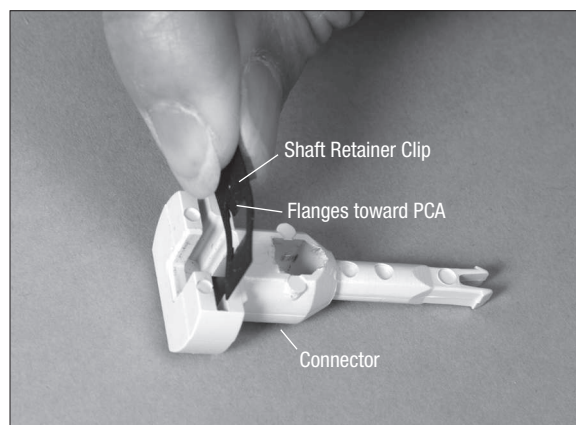

---

## **REPLACE THE CONNECTOR OR GEAR ASSIST (IF NECESSARY)**

### **Insert the Shaft into the Connector or Gear Assist**

- Insert the shaft through the shaft retaining clip, all the way into the connector or gear assist. The end of the shaft should be seated securely, butted up against the walls of the connector or gear assist.

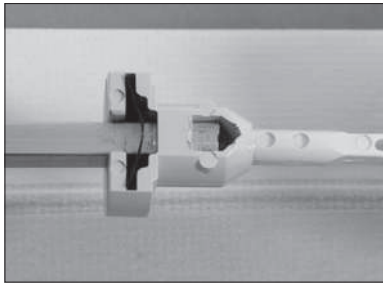

### **Attach the Connector or Gear Assist to the PCA**

- See “Attach the Connector or Gear Assist (for Wider Shades) to the New PCA” on page 7.

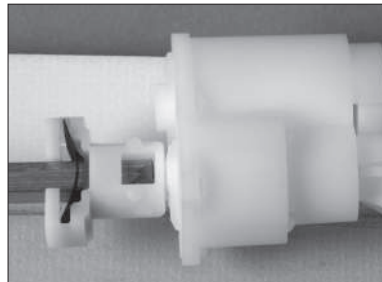

---

## REASSEMBLE THE SHADE

### Insert the Tab on the New PCA into the Fabric Hole

- The hole is 2" from the end of the fabric stack.

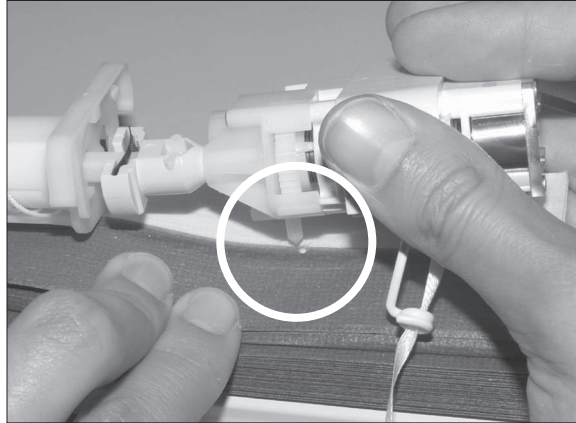

### Slide the PCA into the Headrail

- The PCA, fabric stack, and bottom rail will slide together.

**WARNING:** Be careful not to snag, nick, or cut the fabric or tape hanging down from the PCA.



## REASSEMBLE THE SHADE

---

### Reinstall the End Cap

- Tap the end cap securely in place, then check the operation of the shade.

**NOTE:** Hold the fabric open so the fabric cells are not crushed.

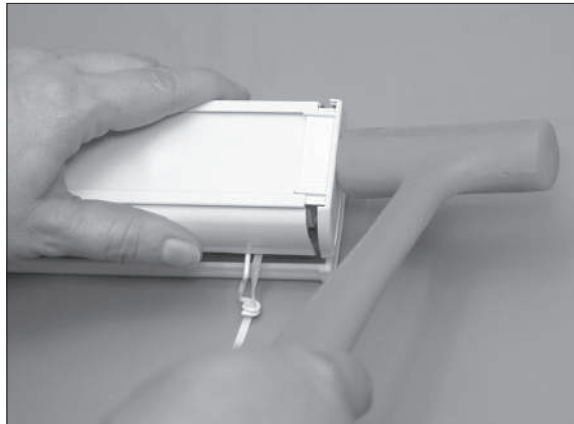

### Check for any Caught Fabric

- Turn the headrail over and check the fabric. The end cap should fit snugly and will not crush or bend the fabric.

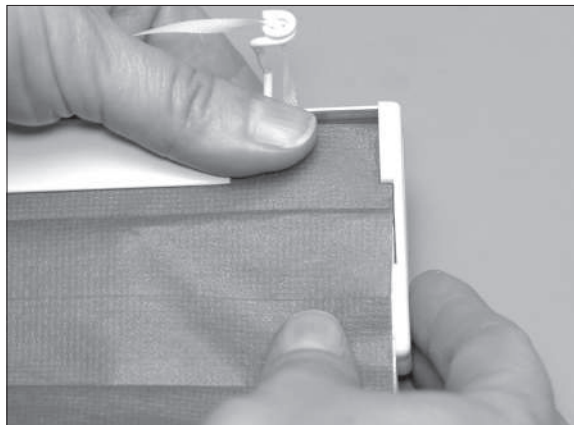

## TRANSFER THE TASSEL ASSEMBLY

### Remove the Tassel from the Old PCA

- Hold the tassel cord while pulling upward on the tassel to pull out the equalizer housing.

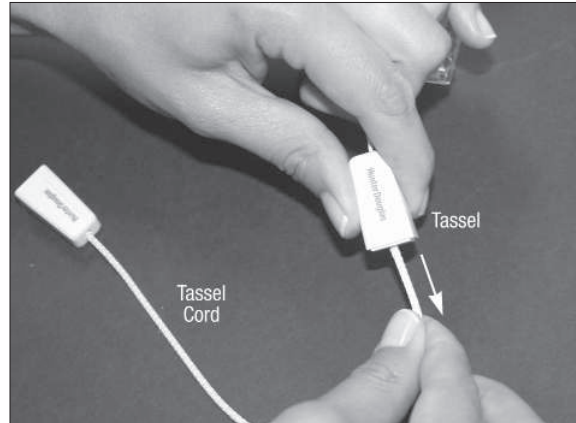

### Release the Equalizer Housing from the Tassel Cover

- Unwrap the lift tape from the old PCA from around the base of the equalizer housing.
- Pull up on the old lift tape to remove the equalizer from the housing.

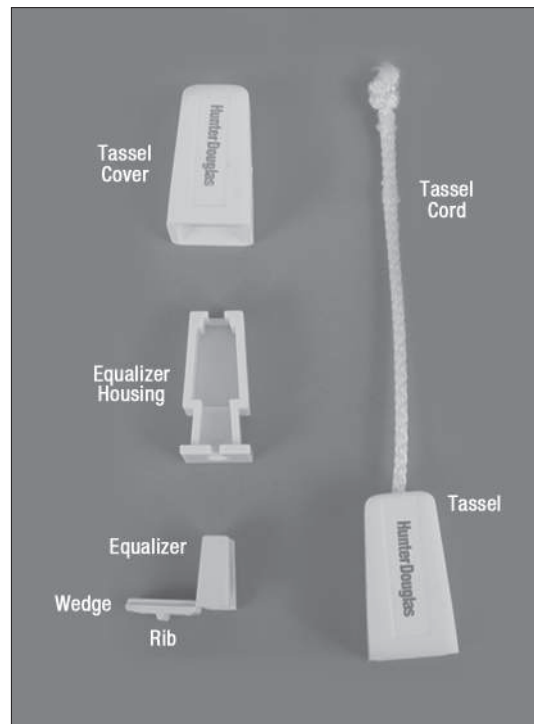

## TRANSFER THE TASSEL ASSEMBLY

---

### Release the Wedge from the Equalizer

- While holding the equalizer, use a flat blade screwdriver to release the wedge.
- Unwrap the old lift tape from the equalizer and tassel cover.
- Discard the old PCA.

### Reassemble the Tassel to the *New PCA*

- Slide the tassel cover, hole-end first, onto the lift tape of the new PCA.

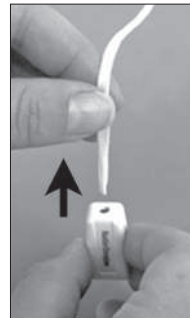

- Loop the tape once around the equalizer.



- Insert the wedge with the rib side toward the tape and the inside of the equalizer.
- Push the wedge up until flush to lock the tape loop into place.



## TRANSFER THE TASSEL CORD ASSEMBLY / REINSTALL THE SHADE

- Place the equalizer into the equalizer housing.

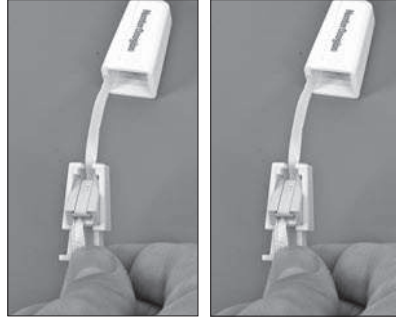

- Re-attach the tassel cord (removed from the old PCA) by sliding the knot into the bottom of the equalizer housing.

- Wrap excess lift tape around the base of the equalizer housing. Do not wrap more than three times. Excess cord around the base will cause the tassel cover to crack.

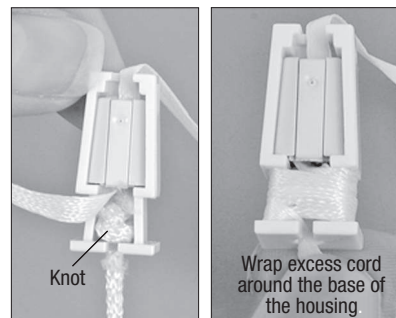

- Slide the tassel cover firmly over the equalizer housing.
- Cut the excess lift tape so it is flush with the bottom of the equalizer housing.



### Reinstall the Shade

- Position the shade so that the front side (colored fabric) faces you.
- Slip the headrail into the installation brackets so that the front of the brackets slide under the front groove on the top of the headrail.
- Gently roll the back of the headrail up and push back to snap the shade into place.

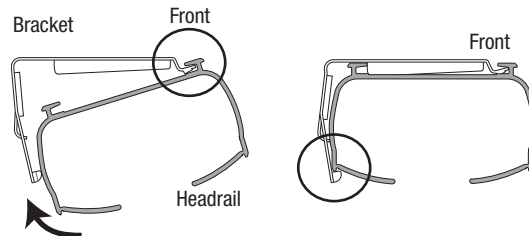

## CHILD SAFETY

---

	<p><b>! WARNING</b></p> <p>For more safety information call 1-888-501-8364 in the U.S. or 1-866-662-0666 in Canada.</p>
---	---

Young children can wrap cords around their necks and STRANGLE.

- Always keep cords out of the reach of children.
- Move cribs, playpens and other furniture away from cords. Children can climb furniture to get to cords.
- Do not tie cords together. Make sure cords do not twist together and create a loop.

**Questions? Call the Hunter Douglas  
Customer Information Center at  
1-888-501-8364  
Visit our Web site at [hunterdouglas.com](http://hunterdouglas.com)**

# HunterDouglas

[hunterdouglas.com](http://hunterdouglas.com)

5109600089



5/11